



FILTRI

www.bsbfiltri.it

CATALOGO FILTRI
GPL & METANO

ed. 2020

LPG & CNG FILTERS CATALOGUE
CATALOGUE DE FILTRES LPG ET CNG
LPG UND CNG FILTER KATALOG
CATÁLOGO DE FILTROS PARA LPG Y CNG

FILTRI FILTERS



www.bsbfiltri.it



FILTRI

www.bsbfiltri.it

CATALOGO 2020



FILTRI

www.bsbfiltri.it

INDICE dei CONTENUTI

FILTRI COMPLETI	7
CARTUCCE FILTRO	13
CARTUCCE METANO	23
SCHEMA IMPIANTO GPL	24

Insieme filtrante GPL e Metano in fase gassosa, stretto da una parte, monouso.

Disposable LPG and CNG dry gas filter unit, one side clenched.

Der LPG und CNG Einwegfiltersatz der gasförmigen Phase, einseitig eingeklemmt.



 **Filtri Completi**
 **Complete Filters**
 **Komplette Filter**

Cartuccia di carta
Paper filter cartridge
Papierfiltereinsatz

Cartuccia di poliestere con/senza rete
Polyester filter cartridge with/out wire mesh
Polyesterfiltereinsatz mit/ohne Netz

Cartuccia in Fibra di Vetro
Fiberglass cartridge
Glasfaser-Filtereinsatz

FILTRI GPL COMPLETI, MONOUSO, CHIUSI SUI DUE LATI

CON CARTUCCIA IN BULPREN®			
WITH BULPREN® CARTRIDGE			
MIT BULPREN® KARTUSCHE			
SINGOLA AGGRAFFATURA - SINGLE SEAM - EINGEKLEMMT			
LUNGHEZZA / LENGTH / LÄNGE 82 mm / Ø 46 mm			
Ø out Ø in	11 mm	12 mm	14 mm
11 mm	FGL 1401		
12 mm		FGL 1402	
14 mm			FGL 1400

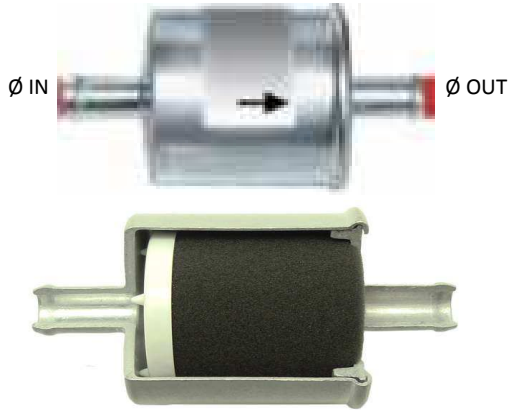



Su richiesta disponibile anche con uscite multiple.
 Also available on demand with various outlets.
 Auf Anfrage auch mit verschiedenen outlets erhältlich.

Su richiesta disponibile anche la versione con cartuccia sostituibile (FGL 2***).
 On request also available the version with replaceable cartridge (FGL 2***).
 Auf Anfrage auch die Version mit austauschbarer Patrone (FGL 2***) erhältlich.

FILTRI GPL COMPLETI, MONOUSO, CHIUSI SUI DUE LATI

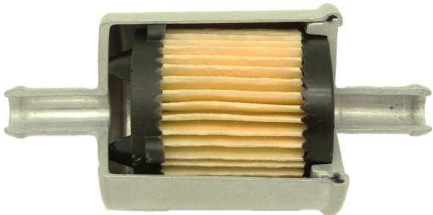
CON CARTUCCIA IN CARTA				
WITH PAPER CARTRIDGE				
MIT PAPIERKARTUSCHE				





∅ IN → ∅ OUT

CARTUCCIA IN CARTA

DOPPIA AGGRAFFATURA - DOUBLE SEAM - EINERSEITS EINGEKLEMMT ANDERSEITZ GESCHLOSSEN und SPRENGRING				
LUNGHEZZA / LENGTH / LÄNGE 99 mm / ∅ 50 mm				
∅ out ∅ in	11 mm	12 mm	14 mm	16 mm
11 mm	FGL 1001			
12 mm		FGL 1002		
14 mm			FGL 1000	
16 mm				FGL 1003

LUNGHEZZA / LENGTH / LÄNGE 122 mm / ∅ 50 mm				
∅ out ∅ in	11 mm	12 mm	14 mm	16 mm
11 mm	FGL 1501			
12 mm		FGL 1502		
14 mm			FGL 1500	
16 mm				FGL 1503

CON CARTUCCIA IN POLIESTERE				
WITH POLYESTER CARTRIDGE				
MIT POLYESTERPATRONE				

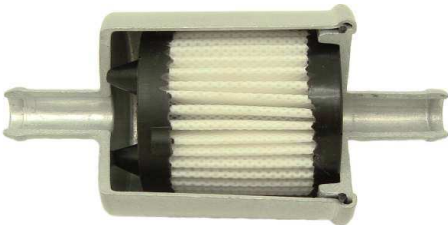



∅ IN → ∅ OUT

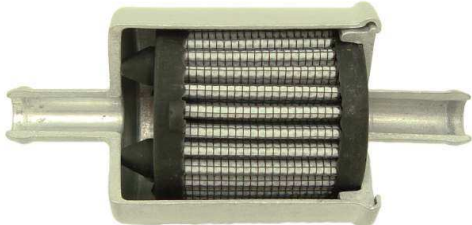

CARTUCCIA IN POLIESTERE SENZA RETE

CARTUCCIA IN POLIESTERE CON RETE

DOPPIA AGGRAFFATURA - DOUBLE SEAM - EINERSEITS EINGEKLEMMT ANDERSEITZ GESCHLOSSEN und SPRENGRING				
LUNGHEZZA / LENGTH / LÄNGE 99 mm / ∅ 50 mm				
∅ out ∅ in	11 mm	12 mm	14 mm	16 mm
11 mm	FGL 1001/P			
12 mm		FGL 1002/P		
14 mm			FGL 1000/P	
16 mm				FGL 1003/P



LUNGHEZZA / LENGTH / LÄNGE 122 mm / ∅ 50 mm				
∅ out ∅ in	11 mm	12 mm	14 mm	16 mm
11 mm	FGL 1501/P			
12 mm		FGL 1502/P		
14 mm			FGL 1500/P	
16 mm				FGL 1503/P

Su richiesta disponibile anche con uscite multiple.
 Also available on demand with various outlets.
 Auf Anfrage auch mit verschiedenen outlets erhältlich.

Su richiesta disponibile anche la versione con cartuccia sostituibile (FGL 2***).
 On request also available the version with replaceable cartridge (FGL 2***).
 Auf Anfrage auch die Version mit austauschbarer Patrone (FGL 2***) erhältlich.

FILTRI GPL COMPLETI, MONOUSO, CHIUSI SUI DUE LATI

CON CARTUCCIA IN FIBRA DI VETRO				
WITH GLASS FIBER CARTRIDGE				
MIT GLASFASERPATRONE				

CARTUCCIA IN FIBRA DI VETRO CON RETE

DOPPIA AGGRAFFATURA - DOUBLE SEAM - EINERSEITS EINGEKLEMMT ANDERSEITZ GESCHLOSSEN und SPRENGRING				
LUNGHEZZA / LENGTH / LÄNGE 99 mm / Ø 50 mm				
Ø out Ø in	11 mm	12 mm	14 mm	16 mm
11 mm	FGL 1001/FVR			
12 mm		FGL 1002/FVR		
14 mm			FGL 1000/FVR	
16 mm				FGL 1003/FVR

LUNGHEZZA / LENGTH / LÄNGE 122 mm / Ø 50 mm				
Ø out Ø in	11 mm	12 mm	14 mm	16 mm
11 mm	FGL 1501/FVR			
12 mm		FGL 1502/FVR		
14 mm			FGL 1500/FVR	
16 mm				FGL 1503/FVR

Su richiesta disponibile anche con uscite multiple.
 Also available on demand with various outlets.
 Auf Anfrage auch mit verschiedenen outlets erhältlich.

Su richiesta disponibile anche la versione con cartuccia sostituibile (FGL 2***).
 On request also available the version with replaceable cartridge (FGL 2***).
 Auf Anfrage auch die Version mit austauschbarer Patrone (FGL 2***) erhältlich.

FILTRI GPL COMPLETI, CON KIT CARTUCCIA DI RICAMBIO IN FIBRA DI VETRO

Ø IN

Ø OUT

LUNGHEZZA / LENGTH / LÄNGE 120 mm X 110 mm X 68 mm

Ø out Ø in	11 mm	12 mm	14 mm	16 mm
11 mm	FGL 1200/FVR			
12 mm		FGL 1201/FVR		
14 mm			FGL 1202/FVR	
16 mm				FGL 1203/FVR

Classe 2.
 La capacità di filtro decantatore: 80 ml.
 La Temperature di funzionamento: -40°C ÷ 120°C.
 La Pressione Massimale di funzionamento 450 kPa.
 Certificato di omologazione: **E8 67R-018231**





KIT CARTUCCIA INTERNA DI RICAMBIO

GPL 45 KIT

Cartuccia filtrante in fibra di vetro **GPL 45 KIT**
 con dispersore di gas in plastica e un o-ring.

GRUPPO FILTRO GPL E GNC MONOUSO DELLA FASE VOLATILE

CON CARTUCCIA IN CARTA WITH PAPER CARTRIDGE MIT PAPERPATRONE		CON CARTUCCIA IN POLIESTERE WITH POLYESTER CARTRIDGE MIT POLYESTERPATRONE																																																	
																																																			
Ø IN		Ø OUT																																																	
SINGOLA AGGRAFFATURA - SINGLE SEAM - EINGEKLEMMT LUNGHEZZA / LENGTH / LÄNGE 98 mm / Ø 47 mm																																																			
<table border="1"> <thead> <tr> <th> $\frac{\text{Ø out}}{\text{Ø in}}$ </th> <th>11 mm</th> <th>12 mm</th> <th>14 mm</th> <th>16 mm</th> </tr> </thead> <tbody> <tr> <td>11 mm</td> <td>FGL 1100</td> <td></td> <td></td> <td></td> </tr> <tr> <td>12 mm</td> <td></td> <td>FGL 1101</td> <td></td> <td></td> </tr> <tr> <td>14 mm</td> <td></td> <td></td> <td></td> <td></td> </tr> <tr> <td>16 mm</td> <td></td> <td></td> <td></td> <td>FGL 1102</td> </tr> </tbody> </table>	$\frac{\text{Ø out}}{\text{Ø in}}$	11 mm	12 mm	14 mm	16 mm	11 mm	FGL 1100				12 mm		FGL 1101			14 mm					16 mm				FGL 1102	<table border="1"> <thead> <tr> <th> $\frac{\text{Ø out}}{\text{Ø in}}$ </th> <th>11 mm</th> <th>12 mm</th> <th>14 mm</th> <th>16 mm</th> </tr> </thead> <tbody> <tr> <td>11 mm</td> <td>FGL 1100/P</td> <td></td> <td></td> <td></td> </tr> <tr> <td>12 mm</td> <td></td> <td>FGL 1101/P</td> <td></td> <td></td> </tr> <tr> <td>14 mm</td> <td></td> <td></td> <td></td> <td></td> </tr> <tr> <td>16 mm</td> <td></td> <td></td> <td></td> <td>FGL 1102/P</td> </tr> </tbody> </table>	$\frac{\text{Ø out}}{\text{Ø in}}$	11 mm	12 mm	14 mm	16 mm	11 mm	FGL 1100/P				12 mm		FGL 1101/P			14 mm					16 mm				FGL 1102/P
$\frac{\text{Ø out}}{\text{Ø in}}$	11 mm	12 mm	14 mm	16 mm																																															
11 mm	FGL 1100																																																		
12 mm		FGL 1101																																																	
14 mm																																																			
16 mm				FGL 1102																																															
$\frac{\text{Ø out}}{\text{Ø in}}$	11 mm	12 mm	14 mm	16 mm																																															
11 mm	FGL 1100/P																																																		
12 mm		FGL 1101/P																																																	
14 mm																																																			
16 mm				FGL 1102/P																																															

Su richiesta disponibile anche con uscite multiple.

Also available on demand with various outlets.

Auf Anfrage auch mit verschiedenen outlets erhältlich.

Classe 2. Temperatura di funzionamento: -40°C ÷ 120°C. Pressione classificata: 450 kPa

Certificato di omologazione FGL 110*: E20-67R-010906, E20-110R-000030

Con la pressione di 1015 kPa nessuna perdita di gas, né deformazioni



FILTRI GPL COMPLETI, CHIUSI SUI DUE LATI, CON CARTUCCIA DI RICAMBIO
COMPLETE LPG FILTERS, CLOSED ON TWO SIDES, WITH SPARE CARTRIDGE
KOMPLETTE LPG-FILTER, AUF ZWEI SEITEN GESCHLOSSEN, MIT ERSATZKARTUSCHE

CON CARTUCCIA IN CARTA		
WITH PAPER CARTRIDGE		
MIT PAPIERKARTUSCHE		
LUNGHEZZA / LENGTH / LÄNGE 53 mm / Ø 6 mm		
Ø out	M12x1	Ø 6 mm
Ø in		
M10x1	FGL 1300	
Ø 6 mm		FGL 1300/K



Kit manutenzione
Repair kit
Reparatursatz

KIT CARTUCCIA DI RICAMBIO
REPAIR KIT
REPARATURSATZ
GPL 44 KIT

FILTRI GPL COMPLETI, PASSANTI, MONOUSO
COMPLETE LPG FILTERS, THROUGH PASSES, SINGLE USE
KOMPLETTE LPG FILTER, DURCH PASS, EINZELNUTZUNG

CON CARTUCCIA COALESCENTE		
WITH COALESCENT CARTRIDGE		
MIT KOHLEKARTUSCHE		
LUNGHEZZA / LENGTH / LÄNGE 133 mm - Ø 58 mm		
Ø out	14 mm	14 mm
Ø in		
14 mm	FGLM 1000 CLASSE 2	FGLM 1000/1 CLASSE 1
	-> a 10 bar	-> a 30 bar

CLASSE 2 PRESSIONI FINO A 10 bar

CROSS

- 71769795 FIAT GROUP (ALFA/FIAT/LANCIA)
- 9255074 GENERAL MOTORS
- 161035001 LANDI RENZO
- 881317 OPEL
- 4600200 UFI







CLASSE 1 PRESSIONI FINO A 30 bar

CROSS



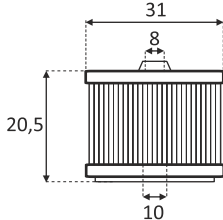

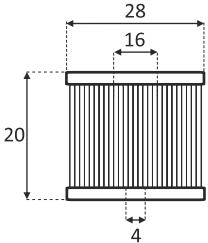

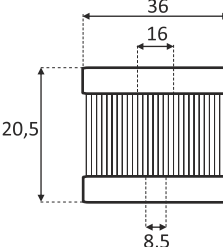

- 51887585 FIAT GROUP (ALFA/FIAT/LANCIA)

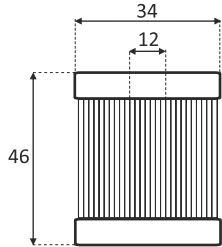

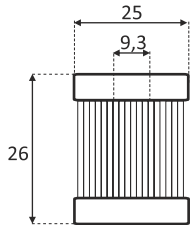

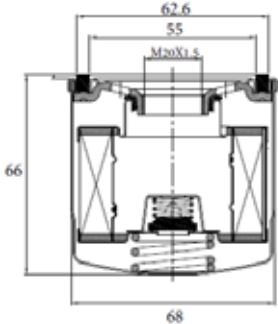

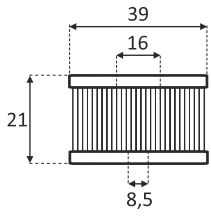

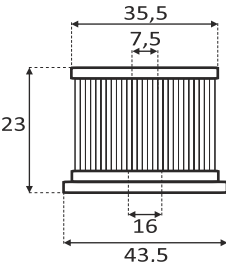

 **Cartucce Filtro**
 **Filter cartridges**
 **Filtereinsätze**

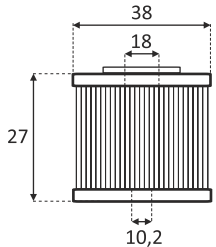
Reference	Type of Filter	Type of Installation	Cross Ref.	Electrovalve	Dimensions of cartridge
GPL 2 	Cartuccia di carta Paper cartridge Papierfiltereinsatz	Prins, Emmagas, Zavoli, Elpigaz, STAG, AC, AG Centrum, MILANO	OMB: ACC5	Valtek (01,02, 03, 07 standard, 07 BFC), Elpigaz (GLP 01,03) MILANO, OMB (MB2 "ALFEA BFC", B2 "ALFEA", DB2 "DIANA")	
GPL 3 	Cartuccia di carta Paper cartridge Papierfiltereinsatz	Landi (LES, LIS) Landi Renzo (IGS, LCS, OMEGAS)	-	LPG Landi, Landi Renzo	
GPL 4 	Cartuccia di carta Paper cartridge Papierfiltereinsatz	AG Centrum	Tomasetto: EGAT2050	Tomasetto: EVG 01 EGAT1001	

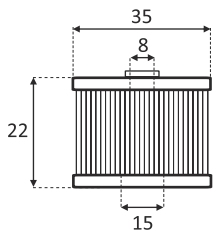

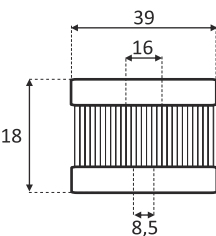

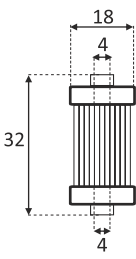

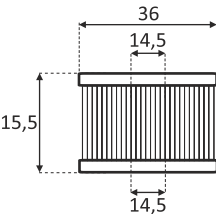

Pezzi di Ricambio / Repair kits / Reparatursätze

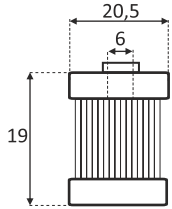
Reference	Type of Filter	Type of Installation	Cross Ref.	Electrovalve	Dimensions of cartridge
GPL 5/10 	Cartuccia di carta Paper cartridge Papierfiltereinsatz	Tartarini	Tartarini: 8960385	-	
GPL 6 	Cartuccia di carta Paper cartridge Papierfiltereinsatz	AC-STAG, Atiker, KME (TUR6, Silver FZ6)	Atiker: FC.061	OMB (GB2"STAR") Atiker (FC.061)	
GPL 11 V 	Cartuccia Filtro in Carta Spin-on Spin-on paper filter cartridge Spin-on papierfiltereinsatz	Comunemente usata su impianti BCR			
GPL 12 	Cartuccia di carta Paper cartridge Papierfiltereinsatz	Lovato, STAG, AC, Landi Renzo		Lovato, Lovato EV	
GPL 13 	Cartuccia di carta Paper cartridge Papierfiltereinsatz	Marini Autogas	Marini Autogas: ELG0009	Marini LPG ELG0006	

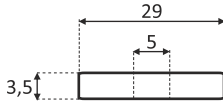

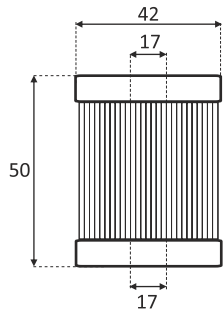

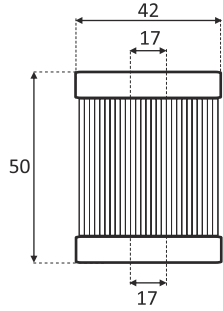

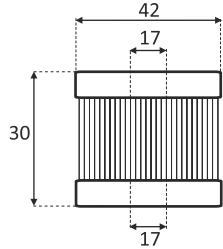

Cartucce Filtranti / Filter cartridges / Filtereinsätze

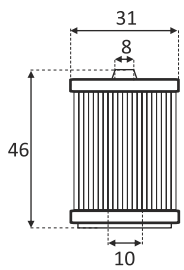
Reference	Type of Filter	Type of Installation	Cross Ref.	Electrovalve	Dimensions of cartridge
GPL 14 	Cartuccia di carta Paper cartridge Papierfiltereinsatz	BRC, ZAVOLI, IMPCO	BRC: PL040011	ET 98 firmy M.T.M. BRC (old type) / ET 98 M.T.M. BRC (old type)	
GPL 15 	Cartuccia di carta Paper cartridge Papierfiltereinsatz	Landi, Tartarini, Koltec, Landi Renzo	Replacement for: MANITOU OEM 453872 LINDE OEM 0009831623 Usage: Linde gas filter serie: 330 (H12/15) 331 (H20/25/30) 350-01/02 (H12/16/18) 350-03 (H12/16/18/20 - 03) 351-01 (H20/25/30) 351-02 (H20/25/30 - 02351-03 H20/25/30/35 - 03) 351-03 (H20/25/30/35 - 03 Renault engine) 351-03 (H20/25/30/35 - 03 Perkins engine)	MED. 3G type 21	
GPL 16 	Cartuccia di carta Paper cartridge Papierfiltereinsatz	Stefanelli	-	-	
GPL 17 	Cartuccia di carta Paper cartridge Papierfiltereinsatz	Tartarini, Koltec, NECAM, Voltran, Atiker, Omnia	Tartarini: 8960140 Atiker: FC.013	1203 Atiker MED.: 4G	
GPL 18 	Cartuccia di carta Paper cartridge Papierfiltereinsatz	Landi Renzo (LCS, IGS, OMEGAS)	MED.: 674072000 Renault: 169191812R	LPG typ 71 - MED	

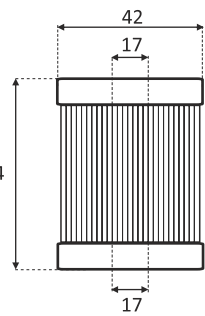

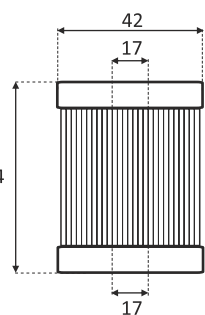

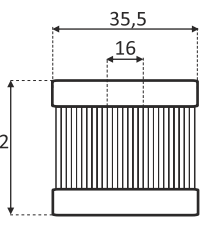

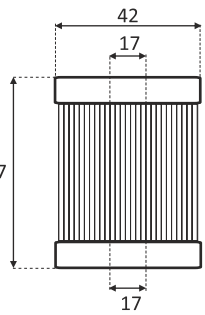

Pezzi di Ricambio / Repair kits / Reparatursätze

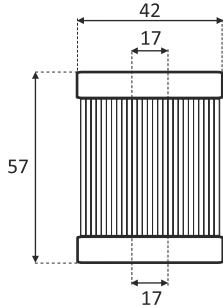
Reference	Type of Filter	Type of Installation	Cross Ref.	Electrovalve	Dimensions of cartridge
GPL 19 	Cartuccia di carta Paper cartridge Papierfiltereinsatz	Romano	Romano: REG	Romano REVG/00	
GPL 20 	Viscosa - Feltro Viscose - Felt Viskose	Bedini ECOgeo 3000 Autogas Italia	OMB: ACC5	Bedini: Maya- AUTOGAS ITALIA	
GPL 22 	Cartuccia di carta Paper cartridge Papierfiltereinsatz	Landi Renzo (OMEGAS)	FIAT: 71754829 UFI: 46 008 00 SOFIMA: S600G Renault: 169195019R	-	
GPL 22/PR 	Cartuccia di poliestere con rete Polyester with wire mesh Polyesterfilterein- satz mit dem Netz	Landi Renzo (OMEGAS)	FIAT: 71754829 UFI: 46 008 00 SOFIMA: S600G Renault: 169195019R	-	
GPL 23/PR 	Cartuccia di poliestere (con rete metallica) Polyester cartridge with wire mesh Polyesterfilterein- satz mit dem Netz	Prins	-	-	

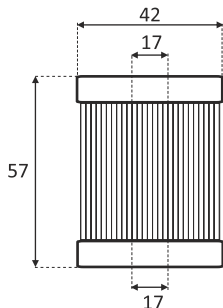

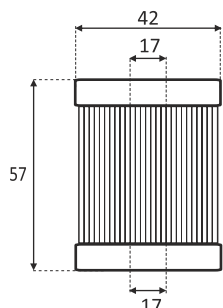

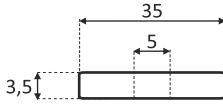

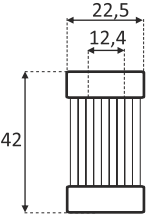

Pezzi di Ricambio / Repair kits / Reparatursätze

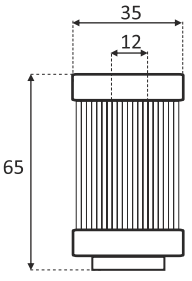
Reference	Type of Filter	Type of Installation	Cross Ref.	Electrovalve	Dimensions of cartridge
GPL 24 	Cartuccia di carta Paper cartridge Papierfiltereinsatz	OMVL (REG) Elpigaz (Stella) STILL R70/RX70, LINDE SERII 39X	-	Valtek: 07 big filter	
GPL 25 	Cartuccia di carta Paper cartridge Papierfiltereinsatz	AG (Zenit, Sirocco), Landi (LSI), ZAVOLI (Alisei N, Alisei Zeta), AC-STAG, BEDINI (ECOgeo 3000), E-GAS (MCE injection), MG motor gas (NewEco DR1)	MATRIX: F30015L PARKER: 1014010136 UFI: 46 007 00 SOFIMA: S6007G	-	
GPL 25/PR 	Cartuccia di poliestere con rete metallica Polyester cartrid- ge with wire mesh Polyesterfilterein- satz mit dem Netz	AG (Zenit, Sirocco), Landi (LSI), ZAVOLI (Alisei N, Alisei Zeta), AC-STAG, BEDINI (ECOgeo 3000), E-GAS (MCE injection), MG motor gas (NewEco DR1)	MATRIX: F30015L PARKER: 1014010136 UFI: 46 007 00 SOFIMA: S6007G	-	
GPL 26 	Cartuccia di carta Paper cartridge Papierfiltereinsatz	EUROPEGAS, AC-STAG, Atiker, Alex, AG Centrum	Tomasetto: RGAT 2070 Atiker: FC.060	-	
GPL 27 	Cartuccia di carta Paper cartridge Papierfiltereinsatz	BRC Czakram BRC	BRC: 09SQ99010005 UFI: 46 005 00 SOFIMA: S6005G Filter M.T.M. BRC FJ1HE	-	

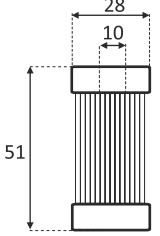

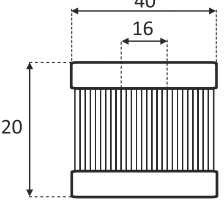

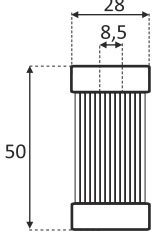

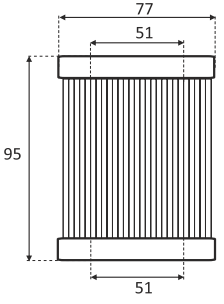

Pezzi di Ricambio / Repair kits / Reparatursätze

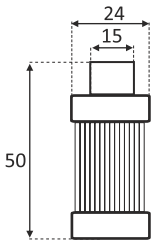
Reference	Type of Filter	Type of Installation	Cross Ref.	Electrovalve	Dimensions of cartridge
GPL 27/P 	Cartuccia di poliestere senza rete metallica Polyester cartridge without wire mesh Polyesterfiltereinsatz ohne Netz	BRC Czakram BRC	BRC: 09SQ99010005 UFI: 46 005 00 SOFIMA: S6005G Filter M.T.M. BRC FJ1HE	-	
GPL 27/PR 	Cartuccia di poliestere con rete metallica Polyester cartridge with wire mesh Polyesterfiltereinsatz mit dem Netz	BRC Czakram BRC	BRC: 09SQ99010005 UFI: 46 005 00 SOFIMA: S6005G Filter M.T.M. BRC FJ1HE	-	
GPL 27/PR KIT 	Cartuccia di poliestere con rete + 4 o-ring Polyester cartridge with wire mesh + 4 orings Polyesterfiltereinsatz mit dem Netz + 4 O-Ringe	BRC Czakram BRC	BRC: 09SQ99010005 UFI: 46 005 00 SOFIMA: S6005G Filter M.T.M. BRC FJ1HE	-	
GPL 28 	Viscosa - Feltro Viscose - Felt Viskose	Bigas	-	Bigas (M.91 i EGM-04)	
GPL 29/CN 	Cartuccia di rete nichel-cromo Cartridge of Chromenickel mesh Filtereinsatz mit dem Chrom-Nikel-Netz	Vialle	-	-	

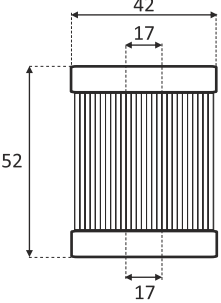
Pezzi di Ricambio / Repair kits / Reparatursätze

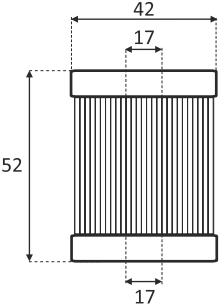
Reference	Type of Filter	Type of Installation	Cross Ref.	Electrovalve	Dimensions of cartridge
GPL 30 	Cartuccia di carta Paper cartridge Papierfiltereinsatz	ICOM (JTG, JTG II, JTG-HP)	-	-	
GPL 31 	Cartuccia di carta Paper cartridge Papierfiltereinsatz	RMG	-	-	
GPL 32 	Cartuccia di carta Paper cartridge Papierfiltereinsatz	Awato	-	Awato	
GPL 33 	Cartuccia di carta Paper cartridge Papierfiltereinsatz	Lovato (Easy Fast - Smart, Easy Fast - OBD II, Easy Fast - DIRECT INJECTION)	Lovato: 1294011	-	
GPL 34 	Cartuccia di carta Paper cartridge Papierfiltereinsatz	ICOM (JTG, JTG II)	-	-	

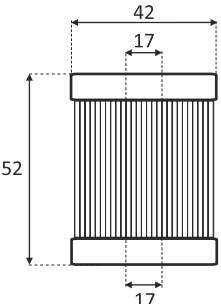

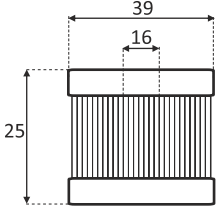
Pezzi di Ricambio / Repair kits / Reparatursätze

Reference	Type of Filter	Type of Installation	Cross Ref.	Electrovalve	Dimensions of cartridge
GPL 35 	Cartuccia di carta Paper cartridge Papierfiltereinsatz	Jungheinrich, Aisan-Nikki - Nissan K21/K25 & Mitsubishi- Pioneer) Nissan - 16919- W1602	Jungheinrich - 50459845 TFG 316 2.06 TFG 320 2.06 TFG 425 9.07 TFG 425 7.04 - 9.07 TFG 430 9.07 - TFG 430 7.04 - 9.07 TFG 435 7.04 - 9.07	Nikki	
GPL 36 	Cartuccia di carta Paper cartridge Papierfiltereinsatz	LOVATO (Easy Fast - Smart, Easy Fast - OBD II, Easy Fast - DIRECT INJECTION)	LOVATO: 4205003, 4205001 UFI: 46 006 00 SOFIMA: S6006G	-	
GPL 36/P 	Cartuccia di poliestere senza rete Polyester cartridge without wire mesh Polyesterfiltereinsatz ohne Netz	LOVATO (Easy Fast - Smart, Easy Fast - OBD II, Easy Fast - DIRECT INJECTION)	LOVATO: 4205003, 4205001 UFI: 46 006 00 SOFIMA: S6006G	-	
GPL 36/PR 	Cartuccia di poliestere con rete metallica Polyester cartridge with wire mesh Polyesterfiltereinsatz mit dem Netz	LOVATO (Easy Fast - Smart, Easy Fast - OBD II, Easy Fast - DIRECT INJECTION)	LOVATO: 4205003, 4205001 UFI: 46 006 00 SOFIMA: S6006G	-	
GPL 37 	Cartuccia di carta Paper cartridge Papierfiltereinsatz	-	-	-	

Pezzi di Ricambio / Repair kits / Reparatursätze



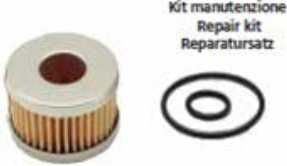
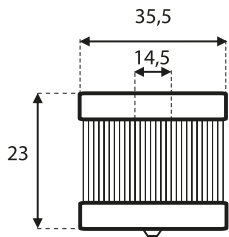

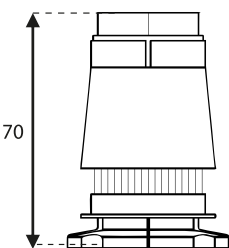

Reference	Type of Filter	Type of Installation	Cross Ref.	Electrovalve	Dimensions of cartridge
GPL 38/FVR 	Cartuccia di fibra di vetro con rete Glass fibre cartridge with wire mesh Glasfaser-filtereinsatz mit dem Netz	Vialle	-	-	
GPL 39 	Cartuccia di carta Paper cartridge Papierfiltereinsatz	BRC (Sequent), ZAVOLI, IMPCO	-	BRC : ET 98, & new type - ET98 MY07	
GPL 39 KIT 	KIT Pezzi di ricambio per GPL 39 Cartuccia di carta + 5 oring (1 o-ring già attaccato alla cartuccia) KIT GPL 39 repair set Paper cartridge + 5 orings (one already assembled inside cartridge) KIT GPL 39 Reparaturset Papierfiltereinsatz +5 ORinge. Einen O-Ring wurde im Inneres des Filtereinsatzes schon montiert.	BRC (Sequent), ZAVOLI, IMPCO	-	BRC : ET 98, & new type - ET98 MY07	
GPL 40/PR 	Cartuccia di poliestere con rete Polyester cartridge with wire mesh Polyester Patrone mit dem Netz	STAG, AC	-	-	
GPL 43 FVR 	Cartuccia di fibra di vetro con rete - per i filtri FGL Fiber glass filter cartridge with wire mesh - used with FGL filters Glasfaserfiltereinsatz - in den Filtern FGL gebraucht				

Pezzi di Ricambio / Repair kits / Reparatursätze

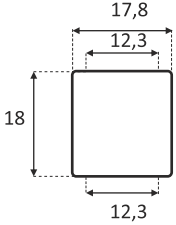
Reference	Type of Filter	Type of Installation	Cross Ref.	Electrovalve	Dimensions of cartridge
<p>GPL 44 KIT</p> 	<p>KIT Cartuccia di ricambio in carta e 2 guarnizioni. KIT Replacement cartridge in paper and 2 gaskets. KIT Ersatzpatrone in Papier und 2 Dichtungen</p>				
<p>GPL 45 KIT</p> 	<p>Cartuccia filtrante in fibra di vetro con dispersore di gas in plastica e un o-ring. Filtering cartridge in glass fiber with plastic gas sink and an o-ring. Filterpatrone aus Glasfaser mit Kunststoff-Gassenke und einem O-Ring.</p>				

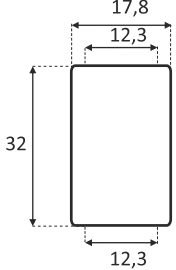
 **Cartucce Metano**
 **Methane Cartridges**
 **Methan Filtereinsätze**

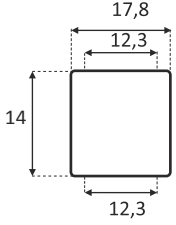
Disponibili in lotti da minimo 10 pezzi oppure per multipli di 10

Reference	Type of Filter	Type of Installation	Cross Ref.	Electrovalve	Dimensions of cartridge
MET 0001 	Composito poliammidevetro The Glass - polyamide composite Versbundstoff Polyamid-Glass	all FIAT group cars (FIAT, Alfa Romeo, Lancia) with CNG systems installed by FIAT 04/2009	FIAT: 71753147	-	
MET 0002 	Composito poliammidevetro The Glass - polyamide composite Versbundstoff Polyamid-Glass	all FIAT group cars (FIAT, Alfa Romeo, Lancia) with CNG systems installed by FIAT 03/2009	FIAT: 60657348	-	
MET 0003 	Composito poliammidevetro The Glass - polyamide composite Versbundstoff PolyamidGlass	all FIAT group cars (FIAT, Alfa Romeo, Lancia) with CNG systems installed by FIAT 04/2009	FIAT: 71771242	-	
MET 0004 	Composito poliammidevetro The Glass - polyamide composite Versbundstoff PolyamidGlass	all FIAT group cars (FIAT, Alfa Romeo, Lancia) with CNG systems installed by FIAT	FIAT: 71753149	-	

SCHEMA RAPPRESENTATIVO DI UN IMPIANTO GPL REPRESENTATIVE IMAGE OF A LPG SYSTEM





FILTRI FILTERS FILTRI FILTERS FILTRI FILTERS FILTRI FILTERS



BSB FILTRI s.r.l.

Via Del Commercio, 6
46035 Ostiglia (MN) Italia
Tel. +39 0386 801977 / 32760
Fax: +39 0386 32400
info@bsbfiltri.it
www.bsbfiltri.it